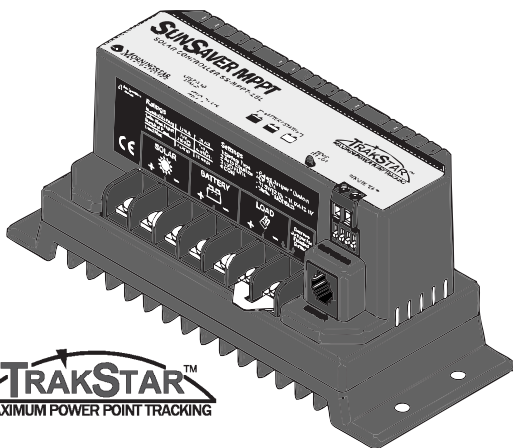


# SUNSAVER MPPT™

WITH TRAKSTAR™ MPPT TECHNOLOGY

## Installation and Operation Manual

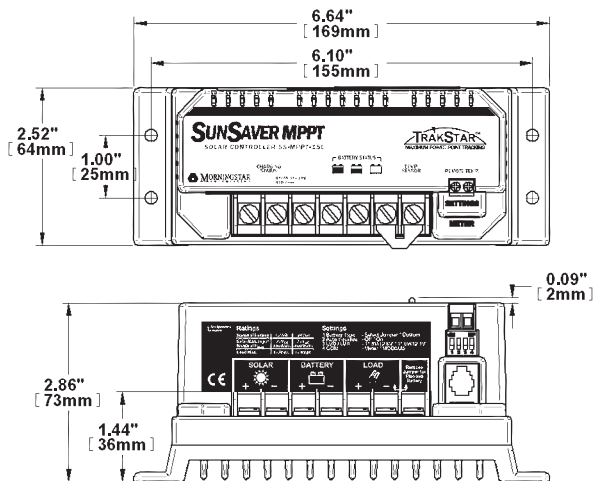


Model: SS-MPPT-15L



**MORNINGSTAR**  
World's Leading Solar Controllers & Inverters  
[www.morningstarcorp.com](http://www.morningstarcorp.com)

## SunSaver MPPT Dimensions



## Specification Summary

System Voltage	12 Volts / 24 Volts
Rated Battery Current	15 Amps
Rated Load Current	15 Amps
Maximum Input Voltage*	75 Volts
Nominal Maximum Input Power**	
12 Volt System	200 Watts
24 Volt System	400 Watts

See Section 7.0 for full technical specifications

\* Array voltage should never exceed maximum input voltage. Refer to the solar module documentation to determine the highest expected array  $V_{oc}$  as defined by the lowest expected ambient temperature for the system location.

\*\* These power levels refer to the maximum wattage the SS-MPPT-15L can process at a certain system voltage. Higher power arrays can be used without damaging the controller, but array cost-benefit will be

## **Contents**

<b>1.0 Important Safety Instructions</b>	<b>4</b>
<b>2.0 General Information</b>	<b>9</b>
2.1 Overview	9
2.2 Features	10
2.3 Optional Accessories	12
2.3 Regulatory Information	13
<b>3.0 Installation Instructions</b>	<b>15</b>
3.1 General Installation Notes	15
3.2 Configuration	16
3.3 Mounting	19
3.4 Wiring	21
<b>4.0 Operation</b>	<b>28</b>
4.1 LED Indications	28
4.2 TrakStar™ MPPT Technology	30
4.3 Battery Charging Information	33
4.4 Load Control Information	35
4.5 Protections	37
4.6 Inspection and Maintenance	39
4.7 Programming Custom Setpoints	40
<b>5.0 Troubleshooting</b>	<b>41</b>
5.1 Error Indications	41
5.2 Common Problems	42
<b>6.0 Warranty</b>	<b>43</b>
<b>7.0 Technical Specifications</b>	<b>44</b>
<b>Appendix A - Wire Chart</b>	<b>49</b>

## 1.0 Important Safety Instructions

### Save These Instructions

This manual contains important safety, installation and operating instructions for the SunSaver MPPT solar controller.

The following symbols are used throughout this manual to indicate potentially dangerous conditions or mark important safety instructions.



**WARNING:** Indicates a potentially dangerous condition. Use extreme caution when performing this task.



**CAUTION:** Indicates a critical procedure for safe and proper operation of the controller.



**NOTE:** Indicates a procedure or function that is important for the safe and proper operation of the controller.

### General Safety Information

- Read all of the instructions and cautions in the manual before beginning installation.
- There are no user serviceable parts inside the SunSaver MPPT. Do not disassemble or attempt to repair the controller.
- Disconnect all sources of power to the controller before installing or adjusting the SunSaver MPPT.
- There are no fuses or disconnects inside the SunSaver MPPT. Install external fuses/breakers as required.
- Do not allow water to enter the controller.
- Confirm that power connections are tightened to avoid excessive heating from a loose connection.



**CAUTION:**  
**A BATTERY CAN PRESENT A RISK OF ELECTRICAL SHOCK, BURN FROM HIGH SHORTCIRCUIT CURRENT, FIRE OR EXPLOSION FROM VENTED GASES. OBSERVE PROPER PRECAUTIONS;**



**NOTE:**  
**PROPER DISPOSAL OF BATTERIES IS REQUIRED. REFER TO YOUR LOCAL CODES FOR DISPOSAL REQUIREMENTS;**



**WARNING:**  
*These servicing instructions are for use by qualified personnel only. To reduce the risk of electric shock, do not perform any servicing other than that specified in the operating instructions unless you are qualified to do so.*



**WARNING:**  
**EXPLOSION HAZARD - DO NOT DISCONNECT WHILE CIRCUIT IS LIVE UNLESS AREA IS KNOWN TO BE NON-HAZARDOUS.**



**CAUTION:**  
*To reduce the risk of fire, connect only to a circuit provided with a maximum branch-circuit overcurrent protection rating not to exceed the model current rating on page 2 and in accordance with the National Electrical Code, ANSI/NFPA 70.*

## Informations de sécurité

- Lisez toutes les instructions et les avertissements figurant dans le manuel avant de commencer l'installation.
- Le SunSaver ne contient aucune pièce réparable par l'utilisateur. Ne démontez pas ni ne tentez de réparer le contrôleur.
- Déconnectez toutes les sources d'alimentation du contrôleur avant d'installer ou de régler le SunSaver.
- Le SunSaver ne contient aucun fusible ou interrupteur. Ne tentez pas de réparer.
- Installez des fusibles/cope-circuits externes selon le besoin.



**ATTENTION:**

**UNE BATTERIE PEUT PRÉSENTER UN RISQUE ÉLEVÉ DE CHOC ÉLECTRIQUE, DE BRÛLURES SUITE À UN COURANT DE COURT-CIRCUIT ÉLEVÉ, À UN INCENDIE OU À UNE EXPLOSION PROVENANT DE GAZ REJETÉS DANS L'AIR. VEUILLEZ PRENDRE LES PRÉCAUTIONS NÉCESSAIRES.**



**AVERTISSEMENT:**

**Ces instructions d'entretien sont exclusivement réservées à des techniciens qualifiés. Pour réduire le risque de choc électrique, ne réalisez aucun entretien autre que celui stipulé dans les instructions de fonctionnement, à moins que vous ne possédiez les qualifications nécessaires en la matière.**



**AVERTISSEMENT:**

**RISQUE D'EXPLOSION. NE PAS DEBRANCHER TANT QUE LE CIRCUIT EST SOUS TENSION, A MOINS QU'IL NE S'AGISSE D'UN EMPLACEMENT NON DANGEREUX.**



**ATTENTION:**

**Pour diminuer le risque d'incendie, ne connectez l'alimentation qu'à un circuit équipé d'une protection maximum par dérivation contre les surintensités ne dépassant pas le courant nominal du modèle de la page 2, conformément à la norme du Code National de l'Électricité (NEC), ANSI/NFPA 70.**

# Installation Safety Precautions

**WARNING:**

*This unit is not provided with a GFDI device. This charge controller must be used with an external GFDI device as required by the Article 690 of the National Electrical Code for the installation location.*

- Mount the SunSaver-MPPT indoors. Prevent exposure to the elements and do not allow water to enter the controller.
- Install the SunSaver in a location that prevents casual contact. The SunSaver heatsink can become very hot during operation.
- Use insulated tools when working with batteries.
- Avoid wearing jewelry during installation.
- The battery bank must be comprised of batteries of same type, make, and age.
- Do not smoke in the vicinity of the battery bank.
- Mount the controller at least 3 ft (1 m) away from vented batteries unless separated by a barrier or located in a separate compartment.
- Power connections must remain tight to avoid excessive heating from a loose connection.
- Use properly sized conductors and circuit interrupters.
- This charge controller is to be connected to DC circuits only. These DC connections are identified by the symbol below.



**Direct Current Symbol**



**AVERTISSEMENT:**

*L'appareil n'est pas fourni avec un dispositif GFDI. Ce contrôleur de charge doit être utilisé avec un dispositif GFDI externe tel que requis par l'Article 690 du Code électrique national de l'emplacement de l'installation.*

- Montez le SunSaver à l'intérieur. Empêchez l'exposition aux éléments et la pénétration d'eau dans le contrôleur.
- Utilisez des outils isolés pour travailler avec les batteries.
- Évitez le port de bijoux pendant l'installation.
- Le groupe de batteries doit être constitué de batteries du même type, fabricant et âge.
- Ne fumez pas à proximité du groupe de batteries.
- Les connexions d'alimentation doivent rester serrées pour éviter une surchauffe excessive d'une connexion desserrée.
- Utilisez des conducteurs et des coupe-circuits de dimensions adaptées.
- Ce contrôleur de charge ne doit être connecté qu'à des circuits en courant continu. Ces connexions CC sont identifiées par le symbole ci-dessous.



- Le contrôleur SunSaver doit être installé par un technicien qualifié conformément aux réglementations électriques du pays où est installé le produit.
- Un moyen d'assurer la déconnexion de tous les pôles de l'alimentation doit être fourni. Cette déconnexion doit être incorporée dans le câblage fixe.
- À l'aide de la borne de mise à la masse du SunSaver (dans le compartiment de câblage), un moyen permanent et fiable de mise à la terre doit être fourni. La fixation de la mise à la terre doit être fixée contre tout desserrage accidentel.
- Les ouvertures d'entrée au compartiment de câblage du SunSaver doivent être protégées avec un conduit ou une bague.



### 2.1 Overview

Thank you for selecting the SunSaver MPPT charge controller with *TrakStar Technology™*. The SunSaver-MPPT (SS-MPPT) is an advanced maximum power point tracking solar battery charger and load controller for stand-alone PV systems. The controller features a smart tracking algorithm that maximizes the energy from the solar module(s) and also provides load control to prevent over-discharge of the battery.

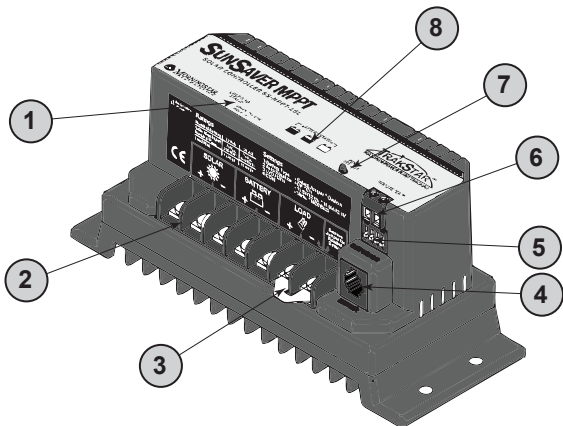
The SS-MPPT battery charging process has been optimized for long battery life and improved system performance. Self-diagnostics and electronic error protection prevent damage when installation mistakes or system faults occur. The controller also features four (4) settings switches for adjustability, a meter port, and terminals for remote battery temperature measurement (optional).

Using MSView™ PC software, the SS-MPPT can be programmed with custom settings to function as a lighting controller to turn the system loads on and off at specified intervals throughout the day and night. *See section 4.7 for more information.*

Although the SS-MPPT is very simple to configure and use, please take the time to read this operator's manual and become familiar with the controller. This will help you make full use of the many advantages the SS-MPPT can provide for your PV system.

## 2.2 Features

The features of the SunSaver MPPT are shown in Figure 1 below. An explanation of each feature is provided.



**Figure 1. SunSaver MPPT features.**

### 1 - Status LED

An LED indicator that shows charging status and also indicates when a solar input fault condition exists.

### 2 - Power Terminal Block

Power terminations for system Solar, Battery, and Load connections.

### 3 - Battery Select Jumper

A removable jumper to select the battery type.

#### 4 - Meter Connection

A communication port for the Morningstar *Remote Meter* or Personal Computer (PC) connection. A *MSC* adapter is required, available separately.

#### 5 - Settings Switches

Adjustment switches that define the operating parameters of the SunSaver MPPT.

#### 6 - Remote Temperature Sensor (RTS) Terminals

Connection point for a Morningstar RTS (optional) to remotely monitor battery temperature.



**NOTE:** *The use of a Remote Temperature Sensor is strongly recommended. Controller location, air flow, and system power can drastically affect the local temperature sensor reading. A RTS will provide optimal charging performance.*

#### 7 - Local Temperature Sensor

Measures ambient temperature. Battery regulation is adjusted based on ambient temperature unless an optional RTS is installed.

#### 8 - Battery Status LEDs

Provides approximate battery *state of charge* indication and also indicates when a system or load fault condition exists.

## 2.3 Optional Accessories

The following accessories are available for purchase separately from your authorized Morningstar dealer.

### Remote Temperature Sensor (Model: RTS)

The RTS measures battery temperature for accurate temperature compensation and is recommended when the ambient battery temperature differs from the ambient controller temperature by +/- 5 degrees C or more. An RTS can be attached to the SunSaver MPPT at any time. The SunSaver MPPT will automatically use the RTS for battery temperature compensation when installed. The standard cable length is 33 ft (10 m), and can be extended to 100 ft (30 m) if required. Installation instructions are provided with the RTS.



***NOTE: The use of a Remote Temperature Sensor is strongly recommended. Controller location, air flow, and system power can drastically affect the local temperature sensor reading. A RTS will provide optimal charging performance.***

### Remote Meter (Model: RM-1)

The digital *Remote Meter* displays system operating information, error indications, and self-diagnostic read-out. Information is displayed on a backlit 4-digit custom LCD display. The large numerical display and icons are easy to read and large buttons make navigating the meter menus easy. Additionally, a status LED and three (3) battery SOC LEDs provide system status at a glance.

The meter can be flush mounted in a wall or surface mounted using the mounting frame (included). The RM-1 is supplied with 33 ft (10.0 m) of cable, a mounting frame, and mounting screws. The RM-1 connects to the RJ- 11 Meter port on the SunSaver MPPT.

### PC MeterBus Adapter™ (Model: MSC)

The *MSC* converts the MeterBus RJ-11 electrical interface to an isolated standard RS-232 interface which enables communication between the SunSaver MPPT and a personal computer (PC). The *MSC* is required for programming custom charging setpoints and for logging data. See *Section 4.7 Programming Custom Setpoints*.

## 2.3 Regulatory Information

**NOTE:**

*This section contains important information for safety and regulatory requirements.*

The SunSaver-MPPT controller should be installed by a qualified technician according to the electrical rules of the country in which the product will be installed.

SunSaver-MPPT controllers comply with the following EMC standards:

- Immunity: EN61000-6-2:1999
- Emissions: EN55022:1994 with A1 and A3 Class B1
- Safety: EN60335-1 and EN60335-2-29 (battery chargers)

A means shall be provided to ensure all pole disconnection from the power supply. This disconnection shall be incorporated in the fixed wiring.

Using the SunSaver-MPPT grounding terminal (in the wiring compartment), a permanent and reliable means for grounding shall be provided. The clamping of the earthing shall be secured against accidental loosening.

The entry openings to the SunSaver-MPPT wiring compartment shall be protected with conduit or with a bushing.

**FCC requirements:**

This device complies with Part 15 of the FCC rules. Operation is subject to the following two conditions: (1) This device may not cause harmful interference, and (2) this device must accept any interference received, including interference that may cause undesired operation.

Changes or modifications not expressly approved by Morningstar for compliance could void the user's authority to operate the equipment.

**Note:**

This equipment has been tested and found to comply with the limits for a Class B digital device, pursuant to Part 15 of the FCC rules. These limits are designed to provide reasonable protection against harmful interference in a residential installation. This equipment generates, uses, and can radiate radio frequency energy and, if not installed and used in accordance with the instruction manual, may cause harmful interference to radio communication. However, there is no guarantee that interference will not occur in a particular installation. If this equipment does cause harmful interference to radio or television reception, which can be determined by turning the equipment on and off, the user is encouraged to try to correct the interference by one or more of the following measures:

- Re-orient or relocate the receiving antenna.
- Increase the separation between the equipment and receiver.
- Connect the equipment into an outlet on a circuit different from that to which the receiver is connected.
- Consult the dealer or an experienced radio/TV technician for help.

This Class B digital apparatus complies with Canadian ICES-003.

Cet appareil numérique de la classe B est conforme à la norme NMB-003 du Canada.

### 3.1 General Installation Notes

- Read through the entire installation section first before beginning installation.
- Be very careful when working with batteries. Wear eye protection. Have fresh water available to wash and clean any contact with battery acid.
- Use insulated tools and avoid placing metal objects near the batteries.
- Explosive battery gasses may be present during charging. Be certain there is sufficient ventilation to release the gasses.
- Do not install in locations where water can enter the controller.
- Loose power connections and/or corroded wires may result in resistive connections that melt wire insulation, burn surrounding materials, or **even cause fire**. Ensure tight connections and use cable clamps to secure cables and prevent them from swaying in mobile applications.
- Only charge lead-acid or NiCd batteries.
- The SunSaver MPPT Battery connection may be wired to one battery or a bank of batteries. The following instructions refer to a singular battery, but it is implied that the battery connection can be made to either one battery or a group of batteries in a battery bank.

## 3.2 Configuration

The four (4) *Settings Switches* and the *Battery Select Jumper* adjust the SS-MPPT battery type, load control, equalization, and communication settings. This section details the configuration for each setting.

### Select a Battery Type

The SS-MPPT provides four (4) different battery types as shown in table 1 below. Use *Settings Switch 1* and the *Battery Select Jumper* to choose the battery type. See *Section 7.0 Technical Specifications* for detailed charging information for each battery type.

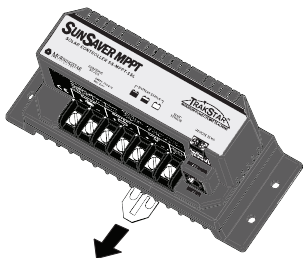
The battery select jumper is secured in the terminal block between terminal #6 and terminal #7 as shown in figure 2. The second column in table 1 specifies whether the jumper should be removed or remain in place, depending on the desired battery type.

Battery Type	Battery Jumper	Switch 1
Gel <sup>1</sup>	INSERTED	ON (↑)
Sealed	INSERTED	OFF (↓)
AGM <sup>1</sup>	REMOVED	ON (↑)
Flooded	REMOVED	OFF (↓)

(1) Setpoints for this battery type can be modified with custom programming. See *Section 4.7 Programming Custom Setpoints* for more information.

**Table 1. Battery Type selection**





**Figure 2. Removing the Battery Select jumper.**

## Load Control – Low Voltage Disconnect / Reconnect

Choose between two (2) load control *Low Voltage Disconnect / Reconnect* settings.

SWITCH 2 OFF (↓):	LVD = 11.50 V, LVR = 12.60 V
SWITCH 2 ON (↑):	LVD = 11.00 V, LVR = 12.10 V <sup>2</sup>

(2) These values can be modified with custom programming. See *Section 4.7 Programming Custom Setpoints* for more information.

## Enable or Disable Auto-Equalization

Turn the auto-equalize feature OFF or ON. The auto-equalize feature will administer an equalization charge (flooded battery type only) every 28 days or if the battery discharges too low the previous night. There is no equalization charge for the gel or sealed battery type.

SWITCH 3 OFF (↓):	AUTO-EQUALIZE OFF
SWITCH 3 ON (↑):	AUTO-EQUALIZE ON (agm, <i>flooded</i> battery type only)

## Communication – Meter / MODBUS®

Choose the desired communication protocol for the RJ-11 meter connection. Select the *Meter* protocol to communicate with a Morningstar Remote Meter (optional accessory).

Select the *MODBUS®* protocol to communicate with a PC<sup>2</sup> and Morningstar's MSView software. *MODBUS®* is an open communication protocol standard used by Morningstar's MSView PC software and other 3rd party hardware / software.

SWITCH 4 OFF (↓):                   MORNINGSTAR REMOTE METER

SWITCH 4 ON (↑):                   MODBUS® PROTOCOL FOR  
MSVIEW, 3RD PARTY DEVICES

(2) Morningstar PC Meterbus Adapter (Model: MSC) required. Not included. See Morningstar's website for more information. [www.morningstarcorp.com](http://www.morningstarcorp.com).

MODBUS® is a registered trademark of Modbus-IDA ([www.modbus-ida.org](http://www.modbus-ida.org))

## 3.3 Mounting



**CAUTION:** *Equipment Damage or Risk of Explosion*  
Never install the SunSaver-MPPT in an enclosure with vented/flooded batteries. Battery fumes are flammable and will corrode and destroy the SunSaver circuits.



**CAUTION:** *Equipment Damage*  
When installing the SunSaver-MPPT in an enclosure, ensure sufficient ventilation. Installation in a sealed enclosure will lead to over-heating and a decreased product lifetime.



**PRUDENCE:** *Endommagement de l'équipement ou risque d'explosion*  
N'installez jamais le SunSaver-MPPT dans une enceinte avec des batteries à évent/à électrolyte liquide. Les vapeurs des batteries sont inflammables et corroderont et détruiront les circuits du SunSaver.



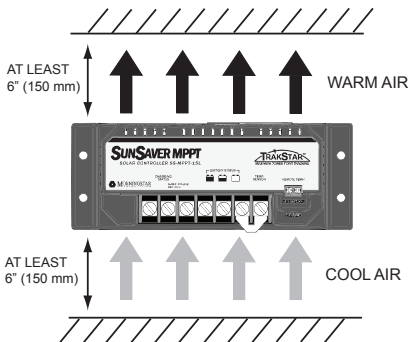
**PRUDENCE:** *Endommagement de l'équipement*  
Assurez une ventilation suffisante en cas d'installation du SunSaver-MPPT dans une enceinte. L'installation dans une enceinte hermétique entraîne une surchauffe et une réduction de la durée de vie du produit.

### Step 1: Choose Mounting Location

Locate the SunSaver-MPPT on a vertical surface protected from direct sun, high temperatures, and water.

### Step 2: Check for Clearance

Place the SunSaver-MPPT in the location where it will be mounted. Verify that there is sufficient room to run wires and that there is ample room above and below the controller for air flow.



**Figure 3. Mounting and cooling**

### Step 3: Mark Holes

Use a pencil or pen to mark the four (4) mounting hole locations on the mounting surface.

### Step 4: Drill Holes

Remove the controller and drill 3/32" (2.5 mm) holes in the marked locations.

### Step 5: Secure Controller

Place the controller on the surface and align the mounting holes with the drilled holes in step 4. Secure the controller in place using the mounting screws (included).

## 3.4 Wiring



**NOTE:** A recommended connection order has been provided for maximum safety during installation. The controller will not be damaged regardless of the sequence of connections.



**NOTE:** The SunSaver-MPPT is a negative ground controller. Any combination of negative connections can be earth grounded as required. Grounding is recommended, but not required for correct operation.



**NOTE:**  
To comply with the NEC, the SunSaver-MPPT must be installed using wiring methods in accordance with Article 690 of the latest edition of the National Electric Code, NFPA 70.



**NOTE:**  
The total current draw of all system loads connected to the SunSaver-MPPT LOAD terminals cannot exceed the controller's load current rating.



**NOTE:**  
For mobile applications, be sure to secure all wiring. Use cable clamps to prevent cables from swaying when the vehicle is in motion. Unsecured cables create loose and resistive connections which may lead to excessive heating and/or fire.



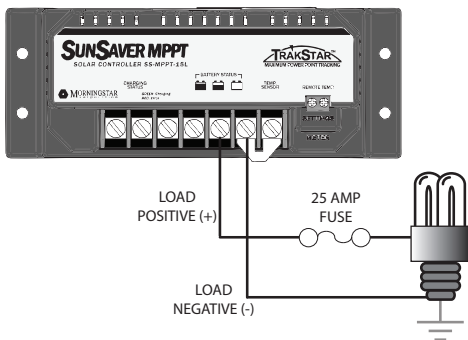
**WARNING:**  
**EXPLOSION HAZARD - DO NOT DISCONNECT WHILE CIRCUIT IS LIVE UNLESS AREA IS KNOWN TO BE NON-HAZARDOUS.**



**AVERTISSEMENT:**  
**RISQUE D'EXPLOSION. NE PAS DEBRANCHER TANT QUE LE CIRCUIT EST SOUS TENSION, A MOINS QU'IL NE S'AGISSE D'UN EMPLACEMENT NON DANGEREUX.**

## Step 1: Load Wiring

The SS-MPPT load output connection will provide battery voltage to system loads such as lights, pumps, motors, and electronic devices. See *Section 4.4 Load Control Information* for more details about load control.



**Figure 4. Load wiring**

Connect load positive (+) and negative (-) load wires to the system load(s) or load distribution panel as shown in figure 4. Refer to the wire gauge chart on page 41 of this manual for correct wire size.

If required, the negative load connection may be earth grounded. Use appropriate gauge wire and proper grounding methods for the installation site.

An in-line fuse holder should be wired in series in the load positive (+) wire as shown. **DO NOT INSERT A FUSE AT THIS TIME.**

If wiring the load connection to a load distribution panel, each load circuit should be fused separately. The total load draw should not exceed the 15 A load rating

## Step 2: Battery Wiring



### **WARNING: Shock Hazard**

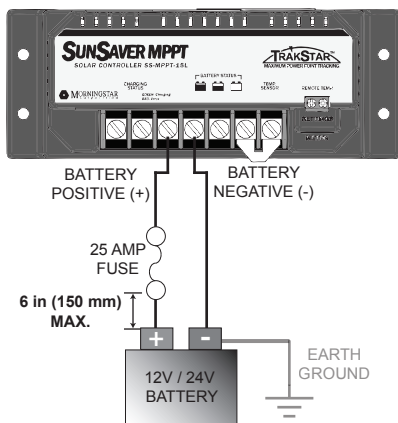
Fuses, circuit breakers, and disconnect switches should never open grounded system conductors. Only GFDI devices are permitted to disconnect grounded conductors.



### **AVERTISSEMENT: Risque de décharge électrique**

Les fusibles, coupe-circuits et interrupteurs ne doivent jamais ouvrir les conducteurs du système mis à la terre. Seuls les dispositifs GFDI sont autorisés à déconnecter les conducteurs reliés mis à la terre.

3.0



**Figure 5. Battery wiring.**

Before connecting the battery, measure the battery voltage. It must be over 7 volts to power the controller. For 24 volt systems, the battery voltage must be greater than 15.5 volts to properly detect a 24V battery. The 12/24 volt battery detection is automatic and the check is only performed at start-up.

Connect the battery to the SS-MPPT. Refer to the wire gauge chart on page 41 of this manual for correct wire size.

If required, the negative battery connection may be earth grounded. Use appropriate gauge wire and proper grounding methods for the installation site.

Wire an in-line fuse holder no more than 6 inches (150 mm) from the battery positive terminal. **DO NOT INSERT A FUSE AT THIS TIME.**



### Step 3: Solar Wiring



**WARNING: Shock Hazard**

The solar PV array can produce open-circuit voltages in excess of 60 Vdc when in sunlight. Verify that the solar input breaker or disconnect has been opened (disconnected) before installing the system wires.



**AVERTISSEMENT: Risque de décharge électrique**

Le réseau PV solaire peut produire des tensions de circuit ouvert supérieures à 60 V cc à la lumière du soleil. Vérifiez que le coupe-circuit ou l'interrupteur d'entrée solaire a été ouvert (déconnexion) avant d'installer les câbles du système.



**WARNING: Risk of Damage**

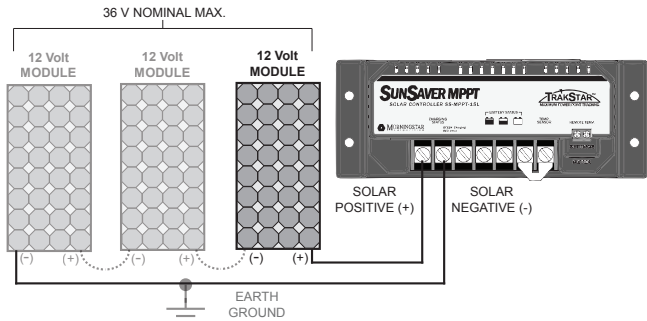
Connecting the solar array to the battery terminal will permanently damage the SunSaver-MPPT.



**AVERTISSEMENT : Risque d'endommagement**

La connexion du réseau solaire sur la borne de la batterie endommagera le SunSaver de façon permanente.

The SunSaver MPPT can accept 12 V , 24 V, or 36 V nominal off-grid solar module arrays. Grid-tie solar module(s) may be used if the open circuit voltage ( $V_{oc}$ ) does not exceed the SS-MPPT 75 Volt maximum solar input rating. The solar module(s) nominal voltage must be equal to or greater than the nominal battery voltage. For 24 V systems, a 24 V or 36 V nominal solar array must be used.



**Figure 6. Solar input wiring.**

Connect the solar module(s) to the SS-MPPT. Refer to the wire gauge chart on page 41 of this manual for correct wire size.

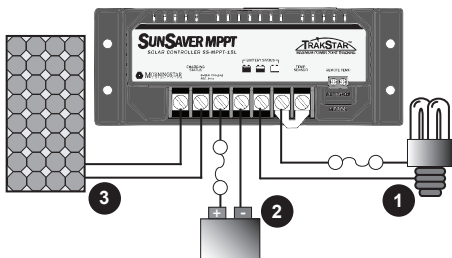
If required, the negative solar connection may be earth grounded. Use appropriate gauge wire and proper grounding methods for the installation site.

### Step 4: Accessories (optional)

Install the *Remote Temperature Sensor* and *Remote Meter* (both purchased separately) if required. Refer to the instructions provided with each accessory for detailed installation procedures.

### Step 5: Confirm Wiring

Double-check the wiring in steps 1 through 4. Confirm correct polarity at each connection. Verify that all seven (7) SS-MPPT power terminals are tightened.



**Figure 7. System Wiring Review**

### Step 6: Install Fuses

Install a 25 Amp DC-rated fuse in each fuse holder in the following order:

1. Load circuit
2. Battery circuit

### Step 7: Confirm Power-up

The SS-MPPT should begin the power-up LED sequence when battery power is applied. Observe that the Battery Status LEDs blink in sequence one time.

If the SS-MPPT does not power up or a flashing LED error sequence exists, refer to *Section 6.0 Troubleshooting*.

### 4.1 LED Indications

#### STATUS LED

The Status LED indicates charging status and any existing solar input error conditions. The Status LED is on when charging during the day and off at night. The Status LED will flash red whenever an error condition(s) exists. Table 2 lists the Status LED indications.

Color	Indication	Operating State
None	Off (with heartbeat <sup>1</sup> )	Night
Green	On Solid ( with heartbeat <sup>2</sup> )	Charging
Red	Flashing	Error
Red	On Solid ( with heartbeat <sup>2</sup> )	Critical Error

<sup>1</sup> heartbeat indication flickers the Status LED on briefly every 5 seconds

<sup>2</sup> heartbeat indication flickers the Status LED off briefly every 5 seconds

**Table 2. Status LED definitions**

For more information on Status LED errors, see *Section 5.1 Error Indications*.

## BATTERY SOC LEDS

Three (3) battery “state of charge” LEDs indicate the level of charge on the battery. The SOC indication is based on battery voltage setpoints alone, which only provides an approximation of the actual state of charge of the battery.

Table 3 lists the SOC LED indications.

SOC LED	Indication	Battery Status	Load Status
Green	Fast Flashing (2 Flash / sec)	Equalize Charge	Load On
Green	Med. Flashing (1 Flash / sec)	Absorption Charge	Load On
Green	Slow Flashing (1 Flash / 2 sec)	Float Charge	Load On
Green	On solid	Nearly Full	Load On
Yellow	On solid	Half Full	Load On
Red	Flashing (1 Flash / sec)	Battery Low	LVD Warning (Load On)
Red	On solid	Battery Empty	LVD (Load Off)

**Table 3. Battery SOC LED definitions**



**NOTE:**

*An error condition exists if multiple Battery SOC LEDs are flashing. See Section 5.1 Error Indications for more information.*

## 4.2 TrakStar™ MPPT Technology

The SS-MPPT utilizes Morningstar's TrakStar Maximum Power Point Tracking technology to extract maximum power from the solar module(s). The tracking algorithm is fully automatic and does not require user adjustment. Trakstar technology will track the array *maximum power point voltage* ( $V_{mp}$ ) as it varies with weather conditions, ensuring that maximum power is harvested from the array through the course of the day.

### Current Boost

In many cases, TrakStar MPPT technology will “boost” the solar charge current. For example, a system may have 2 Amps of solar current flowing into the SS-MPPT and 5 Amps of charge current flowing out to the battery. The SS-MPPT does not create current! Rest assured that the power into the SS-MPPT is the same as the power out of the SS-MPPT. Since power is the product of voltage and current (Volts x Amps), the following is true\*:

- (1) Power Into the SS-MPPT = Power Out of the SS-MPPT
- (2) Volts In x Amps In = Volts Out x Amps Out

\* assuming 100% efficiency. losses in wiring and conversion exist.

If the solar module's  $V_{mp}$  is greater than the battery voltage, it follows that the battery current must be proportionally greater than the solar input current so that input and output power are balanced. The greater the difference between the maximum power voltage and battery voltage, the greater the current boost. Current boost can be substantial in systems where the solar array is of a higher nominal voltage than the battery as described in the next section.

## High Voltage Strings and Grid-tie Modules

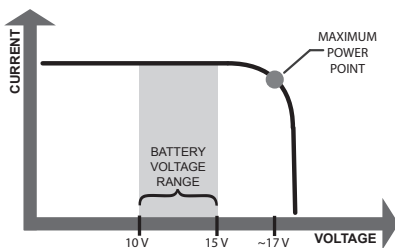
Another benefit of TrakStar MPPT technology is the ability to charge 12 Volt or 24 Volt batteries with solar arrays of higher nominal voltages. A 12V battery bank can be charged with a 12 V, 24 V, or 36 V nominal off-grid solar array.

Certain grid-tie solar modules may also be used as long as the solar array *open circuit voltage* ( $V_{oc}$ ) rating will not exceed the SS-MPPT 75 V maximum input voltage rating at worst-case (coldest) module temperature. The solar module documentation should provide  $V_{oc}$  vs. temperature data.

Higher solar input voltage results in lower solar input current for a given input power. High voltage solar input strings allow for smaller gauge solar wiring. This is especially helpful for systems with long wiring runs between the solar array and the SS-MPPT.

## An Advantage Over Traditional Controllers

Traditional controllers connect the solar module directly to the battery when recharging. This requires that the solar module operate in a voltage range that is below the module's  $V_{mp}$ . In a 12 V system for example, the battery voltage may range from 10 - 15 Vdc but the module's  $V_{mp}$  is typically around 17 V. Figure 8 shows a typical current vs. voltage output curve for a nominal 12V off-grid module.



**Figure 8. Nominal 12 V Solar Module I-V curve**

The array  $V_{mp}$  is the voltage where the product of current and voltage (Amps x Volts) is greatest, which falls on the “knee” of the solar module I-V curve as shown in Figure 8.

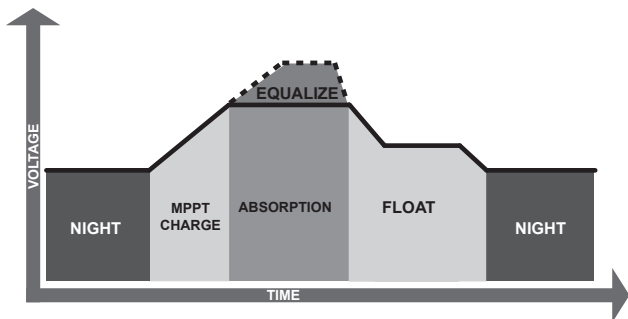
Because Traditional controllers do not operate at the  $V_{mp}$  of the solar array, energy is wasted that could otherwise be used to charge the battery and power system loads. The greater the difference between battery voltage and the  $V_{mp}$  of the module, the more energy is wasted.

TrakStar MPPT technology will always operate at the  $V_{mp}$  resulting in less wasted energy compared to traditional controllers.



## 4.3 Battery Charging Information

The SunSaver MPPT has a 4-stage battery charging algorithm for rapid, efficient, and safe battery charging. Figure 9 shows the sequence of the stages.



**Figure 9. SunSaver MPPT charging algorithm**

### Bulk Charge

In this stage, the battery voltage has not yet reached absorption voltage and 100% of available solar power is used to recharge the battery.

### Absorption

When the battery has recharged to the Absorption voltage setpoint, constant-voltage regulation is used to prevent heating and excessive battery gassing.

### Float

After the battery is fully charged the SS-MPPT reduces the battery voltage to a float charge which is sometimes called a *trickle charge*.

Depending on battery history, the battery remains in the

absorption stage for 3 or 4 hours before transitioning to the float stage.

### **Equalize (flooded battery type only)**

If the auto-equalize feature is enabled, the SS-MPPT will equalize a flooded battery for three (3) hours every 28 days. Equalize charging raises the battery voltage above the standard absorption voltage so that the electrolyte gasses. This process prevents electrolyte stratification and equalizes the individual cell voltages within the battery.



**WARNING: Risk of Explosion**  
*Equalizing vented batteries produces explosive gases. The battery bank must be properly ventilated.*



**CAUTION: Equipment Damage**  
*Excessive overcharging and gassing too vigorously can damage the battery plates and cause shedding of active material from the plates. An equalization that is too high or for too long can be damaging. Review the requirements for the particular battery being used in your system.*



**AVERTISSEMENT: Risque d'explosion**  
*Les batteries à évent et compensation produisent des gaz explosifs. Le groupe de batteries doit être correctement ventilé.*



**PRUDENCE: Endommagement de l'équipement**  
*Une surcharge excessive et un dégagement gazeux trop vigoureux peuvent endommager les plaques de batteries et provoquer l'élimination du matériau actif des plaques. Une compensation trop élevée ou trop longue peut provoquer des dégâts. Examinez les exigences pour la batterie particulière utilisée dans votre système.*

## 4.4 Load Control Information

The primary purpose of the load control function is to disconnect system loads when the battery has discharged to a low state of charge and reconnect system loads when the battery is sufficiently recharged. System loads may be lights, pumps, motors, DC appliances, and other electronic devices. The total current draw of all loads must not exceed the SS-MPPT 15 Amp maximum load rating.



**CAUTION:** Do not wire an AC inverter of any size to the load terminals of the SunSaver MPPT. Damage to the load control circuit may result. Wire inverters directly to the battery or battery bank.

### Load Control Settings

Load control is fully automatic. Choose between two (2) factory Low Voltage Disconnect (LVD) and Low Voltage Reconnect (LVR) settings by adjusting switch #2. See *Section 3.2 Configuration* for more information.

### Current Compensation

All LVD and LVR setpoints are current compensated. Under load the battery voltage will sag in proportion to the current draw of the load. A short-term large load could cause a premature LVD without the current compensation feature. LVD and LVR setpoints are adjusted lower per the following table.

System Voltage	Current Compensation
12 Volt	-15 mV per amp of load
24 Volt	-30 mV per amp of load

**Table 4. Current compensation values.**

## LVD Warning

As the battery discharges the *Battery Status* LEDs will transition from green to yellow and then from yellow to flashing red. The flashing red indication is a warning that a low voltage disconnect event will occur soon. The amount of time between a green SOC indication and load disconnect will depend on many factors including:

- rate of discharge (amount of load draw)
- capacity of the battery
- health of the battery
- LVD setpoint

If the battery discharges to the LVD setpoint the load will disconnect and a solid red Battery Status LED indication will be displayed.

## General Load Control Notes

- A 15 V maximum regulation voltage limit (30 V @ 24 V nominal) exists for all battery types. This limit ensures that the battery and load terminal voltages will never exceed 15 V/30 V. This protects certain DC loads that may be damaged by high input voltage.
- Do not wire multiple SunSaver MPPT load outputs together in parallel to power DC loads with a current draw greater than 15A. Equal current sharing cannot be guaranteed and an over-load condition will likely occur on one or more controllers.
- Exercise caution when connecting loads with specific polarity to a live load circuit. A reverse polarity connection may damage the load. Always double check load connections before applying power.

## 4.5 Protections

### Solar Overload

(No LED indication) The SunSaver MPPT will limit battery current to the 15 Amp maximum rating. An over-sized solar array will not operate at peak power. The solar array should be less than the SS-MPPT *nominal max. input power rating* for optimal performance. See *Section 7.0 Technical Specifications* for more information.

### Load Overload

(Battery Status LEDs: R/Y-G sequencing) If the load current exceeds the maximum load current rating, the SS-MPPT will disconnect the load. The greater the overload the faster the load will be disconnected. A small overload could take a few minutes to disconnect.

The SS-MPPT will attempt to reconnect the load two (2) times. Each attempt is approximately 10 seconds apart. If the overload remains after two (2) attempts, the load will remain disconnected until power is removed and reapplied.

### Solar Short Circuit

(Charging Status LED: OFF) Solar input power wires are short-circuited. Charging automatically resumes when the short is cleared.

### Load Short Circuit

(Battery Status LEDs: R/Y-G sequencing) Fully protected against load wiring short-circuits. After two (2) automatic load reconnect attempts (10 seconds between each attempt), the fault must be cleared by removing and re-applying power.

## **High Voltage Input**

(Charging Status LED: R flashing) If the solar input open circuit voltage ( $V_{oc}$ ) exceeds the 75 volt maximum rating the array will remain disconnected until the  $V_{oc}$  falls safely below the maximum rating.

## **Battery Reverse Polarity**

(No LED indication, not powered) Fully protected against reverse battery connection. No damage to the controller will result. Correct the miswire to resume normal operation.

## **Damaged Local Temperature Sensor**

(Charging Status LED: R on solid) The local ambient temperature sensor is short-circuited or damaged. Charging stops to avoid over- or under-charging. This is a critical error. Contact your authorized Morningstar dealer for service.

## **Damaged Internal Temperature Sensor**

(Charging Status LED: R on solid) The internal heatsink temperature sensor is damaged. This is a critical error. Contact your authorized Morningstar dealer for service.

## **High Temperature**

(Battery Status LED: R-Y sequencing) The heatsink temperature has exceeded safe limits and the load is disconnected. The load will automatically reconnect when the heatsink cools to a safe temperature.

## **Remote Temperature Sensor (RTS)**

(Battery Status LED: R/Y - G/Y sequencing) A bad RTS connection or a severed RTS wire has disconnected the temperature sensor during charging. Charging automatically resumes when the problem is fixed. To resume operation

without a RTS, disconnect all power to the SunSaver MPPT and then reconnect.

### **High Voltage Transients**

Solar, battery, and load power connections are protected against high voltage transients. In lightning prone areas, additional external suppression is recommended.

## **4.6 Inspection and Maintenance**

The following inspections and maintenance tasks are recommended at least two times per year for best controller performance.

- Tighten all terminals. Inspect for loose, broken, or corroded connections.
- Verify that all wire clamps and tie-downs are secure.
- Check that the controller is mounted in a clean, protected environment; free of dirt, insects, nests, and corrosion.
- If applicable, check enclosure ventilation and air flow holes for obstructions.
- Verify LED indication is consistent with the present system conditions.
- Verify that the Remote Temperature Sensor (if used) is securely attached to the RTS terminals.

## 4.7 Programming Custom Set-Points



**CAUTION:** *This feature should only be used by advanced users who have very specific charging and/or load control requirements that are not met using the factory default charge and load control settings. The factory default settings will be sufficient for the vast majority of users.*

Custom charging and load set-points can be programmed into SS-MPPT non-volatile memory using a PC with Morningstar *MSView* software installed and a *Meterbus to Serial Adapter* (model: MSC). Refer to the *MSView* help files for detailed instructions. *MSView* PC software is available for free on our website at:

<http://www.morningstarcorp.com/>

A setup wizard will guide you through the set-point configuration process. Refer to *MSView* help files for more information.

To use custom set-points, the Settings Switches must be adjusted as follows:

**SWITCH #1 ON (↑) TO USE CUSTOM CHARGING SET-POINTS.** USE THE BATTERY SELECT JUMPER TO SELECT BETWEEN TWO SETS OF CUSTOM CHARGING SET-POINTS.

**SWITCH #2 ON (↑) TO USE CUSTOM LOAD CONTROL SET-POINTS.**



**NOTE:** *Use the custom settings wizard to configure and program the controller for Lighting load control. This functionality can only be enabled through custom settings.*



**NOTE:** *Programming custom set-points will overwrite the default Gel and AGM battery type values programmed into custom memory at the factory. Document the new custom values in this manual for future reference.*



## 5.0 Trouble Shooting

### 5.1 Error Indications



**NOTE:** If an optional Morningstar Remote Meter is attached to the SunSaver MPPT, use the self-diagnostic feature to determine the cause of the error indication. Refer to the Remote Meter Operator's Manual for more information.

#### Status LED Error Indications

- |                                 |                        |
|---------------------------------|------------------------|
| • PV High Voltage Disconnect    | Flashing Red           |
| • RTS Shorted                   | Flashing Red           |
| • RTS Disconnected              | Flashing Red           |
| • Damaged local temp. sensor    | Solid Red <sup>1</sup> |
| • Damaged heatsink temp. sensor | Solid Red <sup>1</sup> |
| • Damaged input MOSFETs         | Solid Red <sup>1</sup> |
| • Firmware Error                | Solid Red <sup>1</sup> |

1 - heartbeat indication flickers the Status LED off briefly every 5 seconds

#### Battery Status LED Error Indications

- |                                |                      |
|--------------------------------|----------------------|
| • Load High Voltage Disconnect | R-G Sequencing       |
| • High Temperature Disconnect  | R-Y Sequencing       |
| • Remote Temp. Sensor Error    | Y/R - G/Y Sequencing |
| • External Wiring Error        | G/R-Y Sequencing     |
| • Load Overcurrent             | Y/R-G Sequencing     |
| • Load Short Circuit           | G/R-Y Sequencing     |
| • Custom Setpoints Update      | G/Y/R Flashing       |
| • Self-test Error              | R-Y-G Sequencing     |

## 5.2 Common Problems

**Problem:** No LED indications

**Solution:** With a multi-meter, check the voltage at the battery terminals on the SS-MPPT. Battery voltage must be at least 7V to power the SS-MPPT.

**Problem:** The SS-MPPT is not charging the battery.

**Solution:** If the Status LED is solid or flashing red, see *Section 5.1 Error Indications*. If the Status LED is off, measure the voltage across the Solar input terminals of the SS-MPPT. Input voltage must be greater than battery voltage. Check fuses and solar wiring connections. Check solar array for shading.

**Full testing documentation is available on our website at:**

<http://support.morningstarcorp.com/>

## 6.0 Warranty

The SunSaver MPPT charge controller is warranted to be free from defects in material and workmanship for a period of FIVE (5) years from the date of shipment to the original end user. Morningstar will, at its option, repair or replace any such defective products.

### CLAIM PROCEDURE

Before requesting warranty service, check the Operator's Manual to be certain that there is a problem with the controller. Return the defective product to your authorized Morningstar distributor with shipping charges prepaid. Provide proof of date and place of purchase.

To obtain service under this warranty, the returned products must include the model, serial number and detailed reason for the failure, the module type, array size, type of batteries and system loads. This information is critical to a rapid disposition of your warranty claim.

Morningstar will pay the return shipping charges if the repairs are covered by the warranty.

### WARRANTY EXCLUSIONS AND LIMITATIONS

This warranty does not apply under the following conditions:

- Damage by accident, negligence, abuse or improper use.
- PV or load currents exceeding the ratings of the product.
- Unauthorized product modification or attempted repair.
- Damage occurring during shipment.

THE WARRANTY AND REMEDIES SET FORTH ABOVE ARE EXCLUSIVE AND IN LIEU OF ALL OTHERS, EXPRESS OR IMPLIED. MORNINGSTAR SPECIFICALLY DISCLAIMS ANY AND ALL IMPLIED WARRANTIES, INCLUDING, WITHOUT LIMITATION, WARRANTIES OF MERCHANTABILITY AND FITNESS FOR A PARTICULAR PURPOSE. No Morningstar distributor, agent or employee is authorized to make any modification or extension to this warranty.

MORNINGSTAR IS NOT RESPONSIBLE FOR INCIDENTAL OR CONSEQUENTIAL DAMAGES OF ANY KIND, INCLUDING BUT NOT LIMITED TO LOST PROFITS, DOWNTIME, GOODWILL OR DAMAGE TO EQUIPMENT OR PROPERTY.

1098 Washington Crossing Road,  
Washington Crossing, PA 19877 USA  
Email: [info@morningstarcorp.com](mailto:info@morningstarcorp.com)  
Website: [www.morningstarcorp.com](http://www.morningstarcorp.com)

## 7.0 Technical Specifications

### Electrical

---

Nominal system voltage	12 or 24 Vdc
Max. battery current	15 A
Battery voltage range	7 – 36 V
Max. solar input voltage	75 V
Nominal Maximum Input Power*	
12 Volt	200 Watts
24 Volt	400 Watts
Self-consumption	35 mA
Accuracy	
Voltage	1.0 %
Current	2.0 %
Meter Connection	6-pin RJ-11
Transient Surge Protection	4 x 1500 W

### Battery Charging

---

Regulation Method	4 stage
Temp. Compensation Coefficient	-5 mV / °C / cell (25°C reference)
Temp. Compensation Range	- 30°C to + 60°C
Temp. Compensated Setpoints	Absorption, Float Equalize

### Battery Status LEDs

	Falling V	Rising V	
G to Y	12.1	13.1	Y to G
Y to Flash R	11.7	12.6	Flash R to Y
Flash R to R	11.5	12.6	R to Y

**Note: Multiply x2 for 24 Volt systems.**

\* These power levels refer to the maximum wattage the SS-MPPT-15L can process at a certain system voltage. Higher power arrays can be used without damaging the controller, but array cost-benefit will be reduced at power levels much beyond the nominal ratings.

## Battery Setpoints (@ 25°C)

	Gel	Sealed	AGM	Flooded
Absorption Voltage	14.0 V	14.1 V	14.3 V	14.4 V
Float Voltage	13.7 V	13.7 V	13.7 V	13.7 V
Time until Float	3 hr	3 hr	3 hr	3 hr
Equalize Voltage	N/A	N/A	14.5 V	14.9 V
Equalize Duration	N/A	N/A	3 hrs	3 hrs
Equalize Calendar	N/A	N/A	28 days	28 days
Max. Regulation Voltage <sup>1</sup>	15 V / 30 V			
Low Voltage Disconnect <sup>2</sup>	11.5 V / 11.0 V			
Low Voltage Reconnect <sup>2</sup>	12.6 V / 12.1 V			

<sup>1</sup> Not temperature compensated. 15 V @ 12 V nominal, 30 V @ 24 V nominal

<sup>2</sup> Adjustable by switch, not temperature compensated. 11.0 V / 12.1 V setting can be modified in custom settings.



**NOTE: Temperature compensation increases regulation voltage in cold temperature. A 15 V (30 V @ 24 V nominal) maximum battery voltage limit prevents damage to sensitive DC loads.**

## Environmental

Ambient Temperature Range  
Storage temperature  
Humidity  
Enclosure

-40°C to +60°C  
-55°C to +100°C  
100% N.C.  
IP10 (indoor)

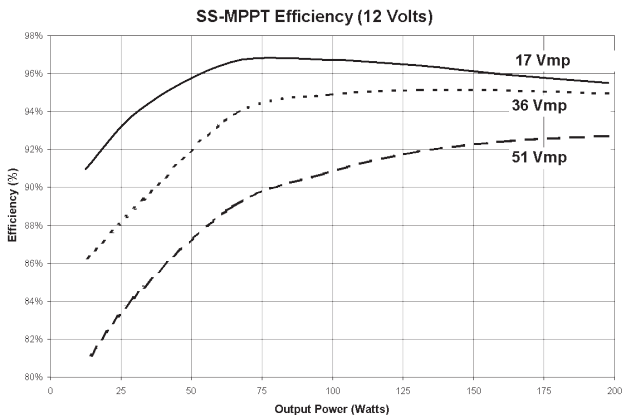
## Mechanical

---

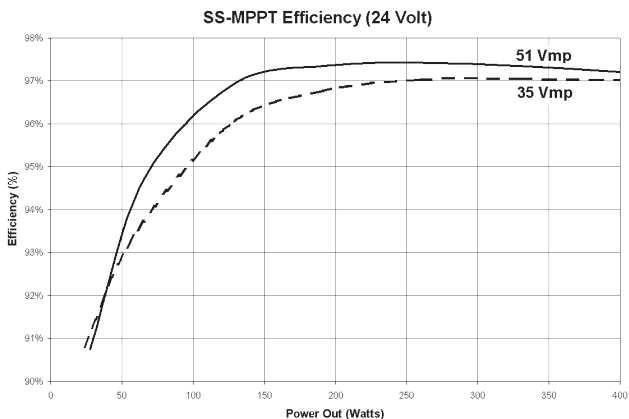
Power terminals wire size (max.)	
Solid	#6 AWG / 16 mm <sup>2</sup>
Multistrand	#6 AWG / 16 mm <sup>2</sup>
Fine strand	#8 AWG / 10 mm <sup>2</sup>
Terminal Diameter	0.210 in / 5.4 mm
Power terminals torque (max.)	35 in-lb / 4 Nm
RTS terminals wire size (max.)	
Wire gauge (min)	#22 AWG / 0.3 mm <sup>2</sup>
Wire gauge (max)	#12 AWG / 3.0 mm <sup>2</sup>
RTS terminals torque (max.)	0.4 Nm / 3.5 in-lb
Dimensions	see inside front cover
Weight	1.3 lbs / 0.60 kg

## Efficiency and Deratings

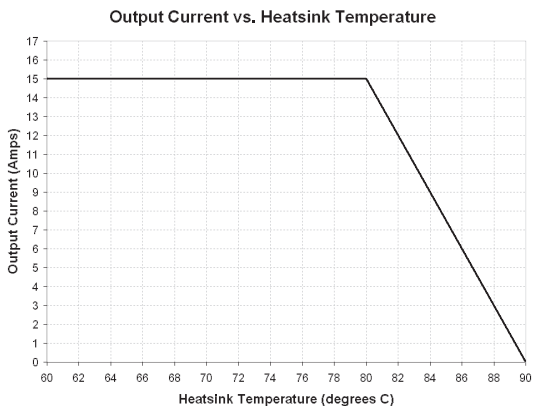
---



**Figure 10. SS-MPPT 12 Volt Efficiency Curves**

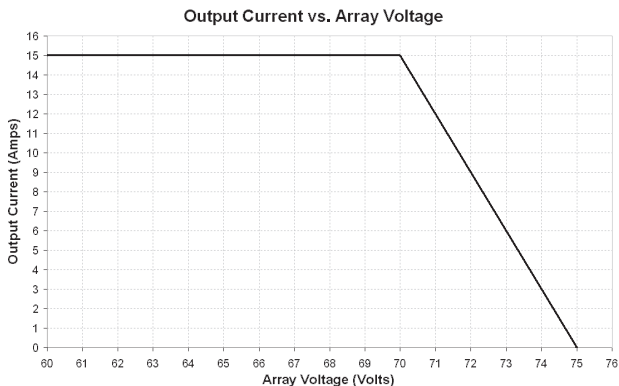


**Figure 11. SS-MPPT 24 Volt Efficiency Curves**



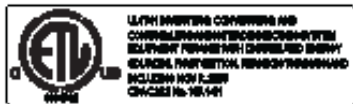
**Figure 12. Output Current vs. Heatsink Temperature**

7.0



**Figure 13. Output Current vs. Array Voltage**

## Certifications



### EMC Directives

- Immunity: EN61000-6-2:1999
- Emissions: EN55022:1994 with A1 and A3 Class B1
- Safety: EN60335-1 and EN60335-2-29 (battery chargers)

Specifications subject to change without notice.

Designed in the U.S.A.

Assembled in Taiwan

© 2013 Morningstar Corporation

MS-ZMAN-SSPPT-C

v03



## Appendix A - Wire Charts

### 12 Volt Nominal Wire Chart

amps	One-way Wire Distance (feet) Wire Gauge (AWG)					One-way Wire Distance (meters) Wire Gauge (mm <sup>2</sup> )				
	14	12	10	8	6	2.0	3.0	5.0	8.0	13.0
<b>2</b>	70	112	180	287	456	21	34	55	87	139
<b>4</b>	35	56	90	143	228	11	17	27	44	69
<b>8</b>	18	28	45	72	114	5	8	14	22	35
<b>12</b>	12	19	30	48	76	4	6	9	15	23
<b>15</b>	9	15	24	38	61	3	5	7	12	19

3% Voltage drop, Annealed copper wire at 20°C

### 24 Volt Nominal Wire Chart

amps	One-way Wire Distance (feet) Wire Gauge (AWG)					One-way Wire Distance (meters) Wire Gauge (mm <sup>2</sup> )				
	14	12	10	8	6	2.0	3.0	5.0	8.0	13.0
<b>2</b>	140	224	360	574	912	43	68	110	175	278
<b>4</b>	70	112	180	286	456	21	34	55	87	139
<b>8</b>	36	56	90	144	228	11	17	27	44	69
<b>12</b>	24	38	60	96	152	7	12	18.3	29	46
<b>15</b>	18	30	48	76	122	5	9	15	23	37

3% Voltage drop, Annealed copper wire at 20°C

### 36 Volt Nominal Wire Chart

amps	One-way Wire Distance (feet) Wire Gauge (AWG)					One-way Wire Distance (meters) Wire Gauge (mm <sup>2</sup> )				
	14	12	10	8	6	2.0	3.0	5.0	8.0	13.0
<b>2</b>	210	336	540	861	1368	64	102	165	262	417
<b>4</b>	105	168	270	429	684	32	51	82	131	208
<b>8</b>	54	84	135	216	342	16	26	41	66	104
<b>12</b>	36	57	90	144	228	11	17	27	44	69
<b>15</b>	27	45	72	114	183	8	14	22	35	56

3% Voltage drop, Annealed copper wire at 20°C